

Test Report

No.: CANEC23007638307

Date: Aug 16, 2023

Page 1 of 36

Client Name: KINGBOARD LAMINATES HOLDINGS LIMITED

Client Address: 23/F., DELTA HOUSE, NO.3 ON YIU STREET, SHATIN, N.T. HONG KONG.

Sample Name: KB-6165F

Model No.: KB-6165F

Client Ref. Information: KB-6165LE

The above sample(s) and information were provided by the client.

SGS Job No.: GZP23-008315

Sample Receiving Date: Aug 07, 2023

Testing Period: Aug 07, 2023 ~ Aug 16, 2023

Test Requested: Select test(s) as requested by the client.

Test Method(s): Please refer to next page(s).

Test Result(s): Please refer to next page(s).

Test Requirement	Conclusion
EU RoHS Directive (EU) 2015/863 amending Annex II to Directive 2011/65/EU- Lead, Mercury, Cadmium, Hexavalent chromium, Polybrominated biphenyls (PBBs), Polybrominated diphenyl ethers (PBDEs), Bis(2-ethylhexyl) phthalate (DEHP), Butyl benzyl phthalate (BBP), Dibutyl phthalate (DBP) and Diisobutyl phthalate (DIBP)	Pass
Targeted 220 Perfluoroalkyl and polyfluoroalkyl substances (PFAS) Content	See Results
Tetrabromobisphenol A (TBBP-A)	See Results
Alkanes C14-C17, chloro (medium- chain chlorinated paraffins) (MCCPs)	See Results
Polycyclic Aromatic Hydrocarbons (PAHs)	See Results
Persistent, Bioaccumulative, and Toxic (PBT) Chemicals under US EPA Toxic Substances Control Act (TSCA) Section 6(h)	Pass
Halogen	See Results
Element(s)	See Results

Signed for and on behalf of
SGS-CSTC Standards Technical Services Co., Ltd. Guangzhou Branch

Jany Zhong
Approved Signatory

scan to see the report



3526220C



SGS-CSTC Standards Technical Services Co., Ltd.
Guangzhou Branch, Chemical Laboratory

Unless otherwise agreed in writing, this document is issued by the Company subject to its General Conditions of Service printed overleaf, available on request or accessible at <https://www.sgs.com/en/Terms-and-Conditions>. Attention is drawn to the limitation of liability, indemnification and jurisdiction issues defined therein. Any holder of this document is advised that information contained hereon reflects the Company's findings at the time of its intervention only and within the limits of Client's instructions, if any. The Company's sole responsibility is to its Client and this document does not exonerate parties to a transaction from exercising all their rights and obligations under the transaction documents. This document cannot be reproduced except in full, without prior written approval of the Company. Any unauthorized alteration, forgery or falsification of the content or appearance of this document is unlawful and offenders may be prosecuted to the fullest extent of the law. Unless otherwise stated the results shown in this test report refer only to the sample(s) tested.
Attention: To check the authenticity of testing /inspection report & certificate, please contact us at telephone: (86-755) 8307 1443, or email: CN.Doccheck@sgs.com

No.198, Kezhu Road, Science City, Economic & Technological Development Area, Guangzhou, Guangdong, China 510663
中国·广东·广州高新技术产业开发区科学城科珠路198号 邮编: 510663

t (86-20) 82155555 www.sgsgroup.com.cn
t (86-20) 82155555 sgs.china@sgs.com

Test Report

No.: CANEC23007638307

Date: Aug 16, 2023

Page 2 of 36

Test Requirement	Conclusion
Red Phosphorus	See Results
Polychlorinated Biphenyls (PCBs)	See Results
Asbestos	See Results
Benzotriazole UV Absorbent	See Results
Bisphenol-A	See Results
Chlorinated Paraffins	See Results
Dimethyl fumarate (DMFu)	See Results
Formaldehyde	See Results
Hexabromocyclododecane (HBCDD)	See Results
Organic-Tin compounds	See Results
Phthalates	See Results
Polyvinyl chloride (PVC)	See Results

Test Result(s):

Test Part Description:

SN ID	Sample No.	SGS Sample ID	Description
SN1	A5	CAN23-0076383-0001.C005	Double-side copper-clad laminate

Remarks:

- (1) 1 mg/kg = 1 ppm = 0.0001%
- (2) MDL = Method Detection Limit
- (3) ND = Not Detected (< MDL)
- (4) "-" = Not Regulated

EU RoHS Directive (EU) 2015/863 amending Annex II to Directive 2011/65/EU- Lead, Mercury, Cadmium, Hexavalent chromium, Polybrominated biphenyls (PBBs), Polybrominated diphenyl ethers (PBDEs), Bis(2-ethylhexyl) phthalate (DEHP), Butyl benzyl phthalate (BBP), Dibutyl phthalate (DBP) and Diisobutyl phthalate (DIBP)

Test Method: With reference to IEC 62321-4:2013+AMD1:2017, IEC 62321-5:2013, IEC 62321-7-2:2017, IEC 62321-6:2015 and IEC 62321-8:2017, analysis was performed by ICP-OES, UV-Vis and GC-MS.

Test Item(s)	Limit	Unit(s)	MDL	A5
Cadmium (Cd)	100	mg/kg	2	ND
Lead (Pb)	1000	mg/kg	2	5
Mercury (Hg)	1000	mg/kg	2	ND
Hexavalent Chromium (Cr(VI))	1000	mg/kg	8	ND
Polybromobiphenyl (PBBs)	1000	mg/kg	-	ND



Unless otherwise agreed in writing, this document is issued by the Company subject to its General Conditions of Service printed overleaf, available on request or accessible at <https://www.sgs.com/en/Terms-and-Conditions>. Attention is drawn to the limitation of liability, indemnification and jurisdiction issues defined therein. Any holder of this document is advised that information contained hereon reflects the Company's findings at the time of its intervention only and within the limits of Client's instructions, if any. The Company's sole responsibility is to its Client and this document does not exonerate parties to a transaction from exercising all their rights and obligations under the transaction documents. This document cannot be reproduced except in full, without prior written approval of the Company. Any unauthorized alteration, forgery or falsification of the content or appearance of this document is unlawful and offenders may be prosecuted to the fullest extent of the law. Unless otherwise stated the results shown in this test report refer only to the sample(s) tested.

Attention: To check the authenticity of testing /inspection report & certificate, please contact us at telephone: (86-755) 8307 1443, or email: CN.Doccheck@sgs.com

Test Report

No.: CANEC23007638307

Date: Aug 16, 2023

Page 3 of 36

Test Item(s)	Limit	Unit(s)	MDL	A5
Monobromobiphenyl (MonoBB)	-	mg/kg	5	ND
Dibromobiphenyl (DiBB)	-	mg/kg	5	ND
Tribromobiphenyl (TriBB)	-	mg/kg	5	ND
Tetrabromobiphenyl (TetraBB)	-	mg/kg	5	ND
Pentabromobiphenyl (PentaBB)	-	mg/kg	5	ND
Hexabromobiphenyl (HexaBB)	-	mg/kg	5	ND
Heptabromobiphenyl (HeptaBB)	-	mg/kg	5	ND
Octabromobiphenyl (OctaBB)	-	mg/kg	5	ND
Nonabromobiphenyl (NonaBB)	-	mg/kg	5	ND
Decabromobiphenyl (DecaBB)	-	mg/kg	5	ND
Polybromodiphenyl ether(PBDEs)	1000	mg/kg	-	ND
Monobromodiphenylether (MonoBDE)	-	mg/kg	5	ND
Dibromodiphenylether (DiBDE)	-	mg/kg	5	ND
Tribromodiphenylether (TriBDE)	-	mg/kg	5	ND
Tetrabromodiphenylether (TetraBDE)	-	mg/kg	5	ND
Pentabromodiphenylether (PentaBDE)	-	mg/kg	5	ND
Hexabromodiphenylether (HexaBDE)	-	mg/kg	5	ND
Heptabromodiphenylether (HeptaBDE)	-	mg/kg	5	ND
Octabromodiphenylether (OctaBDE)	-	mg/kg	5	ND
Nonabromodiphenylether (NonaBDE)	-	mg/kg	5	ND
Decabromodiphenylether (DecaBDE)	-	mg/kg	5	ND
Dibutyl Phthalate(DBP)	1000	mg/kg	50	ND
Benzyl Butyl Phthalate(BBP)	1000	mg/kg	50	ND
Bis-(2-ethylhexyl) Phthalate(DEHP)	1000	mg/kg	50	ND
Diisobutyl Phthalate(DIBP)	1000	mg/kg	50	ND

Notes:

- (1) The maximum permissible limit is quoted from RoHS Directive (EU) 2015/863.
- (2) IEC 62321 series is equivalent to EN 62321 series.
- (3) The restriction of DEHP, BBP, DBP and DIBP shall apply to medical devices, including in vitro medical devices, and monitoring and control instruments, including industrial monitoring and control instruments, from 22 July 2021.

Targeted 220 Perfluoroalkyl and polyfluoroalkyl substances (PFAS) Content

Test Method: With reference to CEN/TS 15968:2010, analysis was performed by LC-MS or LC-MS/MS and GC-MS.

Test Item(s)	CAS No.	Unit(s)	MDL	A5
PFOS, its salts and related compounds				
Perfluorooctane sulfonates (PFOS) ^{Note (1)}	1763-23-1	mg/kg	0.010	ND
N-ethylperfluoro-1-octanesulfonamide (N-EtFOSA)	4151-50-2	mg/kg	0.010	ND
N-methylperfluoro-1-octanesulfonamide (N-MeFOSA)	31506-32-8	mg/kg	0.010	ND
2-(N-ethylperfluoro-1-octanesulfonamido)-ethanol (N-EtFOSE)	1691-99-2	mg/kg	0.010	ND



Unless otherwise agreed in writing, this document is issued by the Company subject to its General Conditions of Service printed overleaf, available on request or accessible at <https://www.sgs.com/en/Terms-and-Conditions>. Attention is drawn to the limitation of liability, indemnification and jurisdiction issues defined therein. Any holder of this document is advised that information contained hereon reflects the Company's findings at the time of its intervention only and within the limits of Client's instructions, if any. The Company's sole responsibility is to its Client and this document does not exonerate parties to a transaction from exercising all their rights and obligations under the transaction documents. This document cannot be reproduced except in full, without prior written approval of the Company. Any unauthorized alteration, forgery or falsification of the content or appearance of this document is unlawful and offenders may be prosecuted to the fullest extent of the law. Unless otherwise stated the results shown in this test report refer only to the sample(s) tested.
Attention: To check the authenticity of testing /inspection report & certificate, please contact us at telephone: (86-755) 8307 1443, or email: CN.Doccheck@sgs.com

Test Report

No.: CANEC23007638307

Date: Aug 16, 2023

Page 4 of 36

Test Item(s)	CAS No.	Unit(s)	MDL	A5
2-(N-methylperfluoro-1-octanesulfonamido)-ethanol (N-MeFOSE)	24448-09-7	mg/kg	0.010	ND
Perfluorooctane Sulfonamide (PFOSA) Note (25)	754-91-6	mg/kg	0.010	ND
Sum of Perfluorooctane sulfonates (PFOS) and its derivatives	-	mg/kg	-	ND
PFOA, its salts				
Perfluorooctanoic acid (PFOA) ^{Note (2)}	335-67-1	mg/kg	0.010	ND
PFOA-related compounds				
1H,1H,2H,2H-Perfluorodecanesulfonic acid (8:2 FTS) ^{Note (3)}	39108-34-4	mg/kg	0.010	ND
Methyl perfluorooctanoate (Me-PFOA)	376-27-2	mg/kg	0.1	ND
Ethyl perfluorooctanoate (Et-PFOA)	3108-24-5	mg/kg	0.1	ND
1H,1H,2H,2H-Perfluoro-1-decanol (8:2 FTOH) ^{Note (3)}	678-39-7	mg/kg	0.1	ND
1H,1H,2H,2H-Perfluorodecyl acrylate (8:2 FTA) ^{Note (3)}	27905-45-9	mg/kg	0.1	ND
1H,1H,2H,2H-Perfluorodecyl methacrylate (8:2 FTMA) ^{Note (3)}	1996-88-9	mg/kg	0.1	ND
Perfluoro-1-iodooctane (PFOL)	507-63-1	mg/kg	0.1	ND
2H,2H-Perfluorodecane Acid (H ₂ PFDA/8:2 FTCA) ^{Note (3), Note (11)}	27854-31-5	mg/kg	0.010	ND
Sum of PFOA-related compounds	-	mg/kg	-	ND
C9-C14 PFCA, their salts				
Perfluorononane Acid (PFNA) ^{Note (4)}	375-95-1	mg/kg	0.010	ND
Perfluorodecane Acid (PFDA) ^{Note (4)}	335-76-2	mg/kg	0.010	ND
Perfluoroundecanoic Acid (PFUnDA) ^{Note (22)}	2058-94-8	mg/kg	0.010	ND
Perfluorododecanoic Acid (PFDoDA) ^{Note (4)}	307-55-1	mg/kg	0.010	ND
Perfluorotridecanoic Acid (PFT _r DA) ^{Note (24)}	72629-94-8	mg/kg	0.010	ND
Perfluorotetradecanoic Acid (PFTDA)	376-06-7	mg/kg	0.010	ND
Perfluoro-3,7-dimethyloctanoic Acid (PF-3,7-DMOA)	172155-07-6	mg/kg	0.010	ND
Sum of C9-C14 PFCA, their salts	-	mg/kg	-	ND
C9-C14 PFCA-related substances				
Perfluorodecane Sulfonate (PFDS) ^{Note (10)}	335-77-3	mg/kg	0.010	ND
1H,1H,2H,2H-Perfluoro-1-dodecanol (10:2 FTOH)	865-86-1	mg/kg	0.1	ND
1H,1H,2H,2H-Perfluorododecylacrylate (10:2 FTA)	17741-60-5	mg/kg	0.1	ND
1-Iodo-1H,1H,2H,2H-perfluorodecane (8:2 FTI)	2043-53-0	mg/kg	0.1	ND
1H,1H,2H,2H-Perfluorodecyltriethoxysilane (8:2 FTSi(OC ₂ H ₅) ₃)	101947-16-4	mg/kg	0.1	ND
2H,2H,3H,3H-Perfluoroundecanoic acid (H ₄ PFUnDA/ 8:3 FTCA) ^{Note (12)}	34598-33-9	mg/kg	0.010	ND



Unless otherwise agreed in writing, this document is issued by the Company subject to its General Conditions of Service printed overleaf, available on request or accessible at <https://www.sgs.com/en/Terms-and-Conditions>. Attention is drawn to the limitation of liability, indemnification and jurisdiction issues defined therein. Any holder of this document is advised that information contained hereon reflects the Company's findings at the time of its intervention only and within the limits of Client's instructions, if any. The Company's sole responsibility is to its Client and this document does not exonerate parties to a transaction from exercising all their rights and obligations under the transaction documents. This document cannot be reproduced except in full, without prior written approval of the Company. Any unauthorized alteration, forgery or falsification of the content or appearance of this document is unlawful and offenders may be prosecuted to the fullest extent of the law. Unless otherwise stated the results shown in this test report refer only to the sample(s) tested.

Attention: To check the authenticity of testing / inspection report & certificate, please contact us at telephone: (86-755) 8307 1443, or email: CN.Doccheck@sgs.com

Test Report

No.: CANEC23007638307

Date: Aug 16, 2023

Page 5 of 36

Test Item(s)	CAS No.	Unit(s)	MDL	A5
1H,1H,2H,2H-Perfluorododecyl methacrylate (10:2 FTMA)	2144-54-9	mg/kg	0.1	ND
1H,1H,2H,2H-perfluorotetradecan-1-ol (12:2 FTOH)	39239-77-5	mg/kg	0.1	ND
1H,1H,2H,2H-Perfluorododecane sulfonic acid (10:2 FTS)	120226-60-0	mg/kg	0.010	ND
1,1,2,2-Tetrahydroperfluorododecyl iodide (10:2 FTI)	2043-54-1	mg/kg	0.1	ND
1H,1H,2H,2H-Perfluorotetradecyl iodide (12:2 FTI)	30046-31-2	mg/kg	0.1	ND
1H,1H,2H,2H-Perfluorodecanesulfonic acid (8:2 FTS) ^{Note (3)}	39108-34-4	mg/kg	0.010	ND
1H,1H,2H,2H-Perfluoro-1-decanol (8:2 FTOH) ^{Note (3)}	678-39-7	mg/kg	0.1	ND
1H,1H,2H,2H-Perfluorodecyl acrylate (8:2 FTA) ^{Note (3)}	27905-45-9	mg/kg	0.1	ND
1H,1H,2H,2H-Perfluorodecyl methacrylate (8:2 FTMA) ^{Note (3)}	1996-88-9	mg/kg	0.1	ND
2H,2H-Perfluorodecane Acid (H2PFDA/8:2 FTCA) ^{Note (3), Note (11)}	27854-31-5	mg/kg	0.010	ND
Sum of C9-C14-related substances	-	mg/kg	-	ND
PFHxS, its salts				
Perfluorohexane Sulfonate (PFHxS) ^{Note (7)}	355-46-4	mg/kg	0.010	ND
PFHxS-related compounds				
N-Methylperfluoro-1-hexanesulfonamide (N-Me-PFHxSA)	68259-15-4	mg/kg	0.010	ND
Perfluorohexane sulfonamide (PFHxSA)	41997-13-1	mg/kg	0.010	ND
N-[3-(dimethylamino)propyl] tridecafluorohexanesulphonamide (N-AP-FHxSA)	50598-28-2	mg/kg	0.010	ND
2-[methyl[(tridecafluorohexyl) sulphonyl]amino]ethyl acrylate) (N-MeFHSEA)	67584-57-0	mg/kg	0.5	ND
Other PFAS				
Perfluorobutane Acid (PFBA) ^{Note (13)}	375-22-4	mg/kg	0.010	ND
Perfluorobutane Sulfonate (PFBS) ^{Note (5)}	375-73-5	mg/kg	0.010	ND
1,1,2,2,3,3,4,4,4-nonafluoro-N-(2-hydroxyethyl)-N-methylbutane-1-sulphonamide (PFBS-NC ₃ H ₈ O)	34454-97-2	mg/kg	0.010	ND
Perfluoropentane Acid (PFPeA) ^{Note (17)}	2706-90-3	mg/kg	0.010	ND
Perfluorohexane Acid (PFHxA) ^{Note (6)}	307-24-4	mg/kg	0.010	ND
Perfluoroheptane Acid (PFHpA) ^{Note (14)}	375-85-9	mg/kg	0.010	ND
Perfluoroheptanesulfonic Acid (PFHpS) ^{Note (8)}	375-92-8	mg/kg	0.010	ND
7H-Dodecanefluoroheptane Acid (7HPFHpA)	1546-95-8	mg/kg	0.010	ND
1H,1H,2H,2H-Perfluorooctanesulphonic acid (6:2 FTS) ^{Note (26)}	27619-97-2	mg/kg	0.010	ND



SGS-CSTC Standards Technical Services Co., Ltd.
Guangzhou Branch, SGS (China) Technical Laboratory

Unless otherwise agreed in writing, this document is issued by the Company subject to its General Conditions of Service printed overleaf, available on request or accessible at <https://www.sgs.com/en/Terms-and-Conditions>. Attention is drawn to the limitation of liability, indemnification and jurisdiction issues defined therein. Any holder of this document is advised that information contained hereon reflects the Company's findings at the time of its intervention only and within the limits of Client's instructions, if any. The Company's sole responsibility is to its Client and this document does not exonerate parties to a transaction from exercising all their rights and obligations under the transaction documents. This document cannot be reproduced except in full, without prior written approval of the Company. Any unauthorized alteration, forgery or falsification of the content or appearance of this document is unlawful and offenders may be prosecuted to the fullest extent of the law. Unless otherwise stated the results shown in this test report refer only to the sample(s) tested.

Attention: To check the authenticity of testing /inspection report & certificate, please contact us at telephone: (86-755) 8307 1443, or email: CN.Doccheck@sgs.com

No.198, Kezhu Road, Science City, Economic & Technological Development Area, Guangzhou, Guangdong, China 510663
中国·广东·广州高新技术产业开发区科学城科珠路198号 邮编: 510663

t (86-20) 82155555 www.sgsgroup.com.cn
t (86-20) 82155555 sgs.china@sgs.com

Test Report

No.: CANEC23007638307

Date: Aug 16, 2023

Page 6 of 36

Test Item(s)	CAS No.	Unit(s)	MDL	A5
1H,1H,2H,2H-Perfluorooctylacrylate (6:2 FTA)	17527-29-6	mg/kg	0.1	ND
1H,1H,2H,2H-Perfluoro-1-hexanol (4:2 FTOH)	2043-47-2	mg/kg	0.1	ND
1H,1H,2H,2H-Perfluoro-1-octanol (6:2 FTOH)	647-42-7	mg/kg	0.1	ND
2,3,3,3-tetrafluoro-2-(heptafluoropropoxy) propionic acid (HFPO-DA) ^{Note (9)}	13252-13-6	mg/kg	0.010	ND
Perfluorooctane sulfonamidoacetic Acid (FOSAA)	2806-24-8	mg/kg	0.010	ND
N-Methylperfluoro-1-octanesulfonamidoacetic Acid (N-MeFOSAA)	2355-31-9	mg/kg	0.010	ND
N-Ethylperfluorooctane sulfonamidoacetic Acid (N-EtFOSAA)	2991-50-6	mg/kg	0.010	ND
Perfluoropentane sulfonic acid (PFPeS) ^{Note (18)}	2706-91-4	mg/kg	0.010	ND
Perfluoro nonane sulfonic acid (PFNS) ^{Note (19)}	68259-12-1	mg/kg	0.010	ND
Perfluoroundecane sulfonic acid (PFUnDS) ^{Note (16)}	749786-16-1	mg/kg	0.010	ND
Perfluorododecanesulfonic acid (PFDoDS) ^{Note (20)}	79780-39-5	mg/kg	0.010	ND
Perfluorotridecane sulfonic acid (PFTrDS) ^{Note (21)}	791563-89-8	mg/kg	0.010	ND
1H,1H,2H,2H-Perfluorohexanesulfonic acid (4:2 FTS)	757124-72-4	mg/kg	0.010	ND
2-Perfluorohexyl ethanoic acid (6:2 FTCA)	53826-12-3	mg/kg	0.010	ND
3-Perfluoropentyl propanoic acid (5:3 FTCA)	914637-49-3	mg/kg	0.010	ND
Perfluorohexadecanoic Acid (PFHxDA)	67905-19-5	mg/kg	0.010	ND
Perfluorooctadecanoic Acid (PFODA)	16517-11-6	mg/kg	0.010	ND
bis(3,3,4,4,5,5,6,6,7,7,8,8,9,9,10,10,10-heptafluorodecyl) hydrogen phosphate (8:2diPAP) ^{Note (15)}	678-41-1	mg/kg	0.010	ND
1H,1H,2H,2H-Perfluorooctyl methacrylate (6:2 FTMA)	2144-53-8	mg/kg	0.1	ND
4,8-Dioxa-3H-perfluoronanoic acid (ADONA)	919005-14-4	mg/kg	0.010	ND
Perfluoro-3-methoxypropanoic acid (PFMPA)	377-73-1	mg/kg	0.010	ND
Perfluoro-4-methoxybutanoic acid (PFMBA)	863090-89-5	mg/kg	0.010	ND
Nonafluoro-3,6-dioxaheptanoic acid (NFDHA)	151772-58-6	mg/kg	0.010	ND
9-Chlorohexadecafluoro-3-oxanonane-1-sulfonic acid (9Cl-PF3ONS)	756426-58-1	mg/kg	0.010	ND



Unless otherwise agreed in writing, this document is issued by the Company subject to its General Conditions of Service printed overleaf, available on request or accessible at <https://www.sgs.com/en/Terms-and-Conditions>. Attention is drawn to the limitation of liability, indemnification and jurisdiction issues defined therein. Any holder of this document is advised that information contained hereon reflects the Company's findings at the time of its intervention only and within the limits of Client's instructions, if any. The Company's sole responsibility is to its Client and this document does not exonerate parties to a transaction from exercising all their rights and obligations under the transaction documents. This document cannot be reproduced except in full, without prior written approval of the Company. Any unauthorized alteration, forgery or falsification of the content or appearance of this document is unlawful and offenders may be prosecuted to the fullest extent of the law. Unless otherwise stated the results shown in this test report refer only to the sample(s) tested.

Attention: To check the authenticity of testing /inspection report & certificate, please contact us at telephone: (86-755) 8307 1443, or email: CN.Doccheck@sgs.com

Test Report

No.: CANEC23007638307

Date: Aug 16, 2023

Page 7 of 36

Test Item(s)	CAS No.	Unit(s)	MDL	A5
11-Chloroeicosafuoro-3-oxaundecane-1-sulfonic acid (11Cl-PF3OUdS)	763051-92-9	mg/kg	0.010	ND
Perfluoro(2-ethoxyethane)sulfonic acid (PFEEESA)	113507-82-7	mg/kg	0.010	ND
3-Perfluoropropyl propanoic acid (3:3 FTCA)	356-02-5	mg/kg	0.010	ND
3-Perfluoroheptyl propanoic acid (7:3 FTCA)	812-70-4	mg/kg	0.010	ND
Perfluoropentadecanoic Acid (PFPeDA)	141074-63-7	mg/kg	0.1	ND
1H,1H,2H,2H-Perfluorohexyl methacrylate (4:2 FTMA)	1799-84-4	mg/kg	0.1	ND
2-(N-ethylperfluorooctanesulfamido) ethyl acrylate (EtFOSAC)	423-82-5	mg/kg	0.1	ND
1H,1H,2H-Heptadecafluoro-1-decene (PFDE)	21652-58-4	mg/kg	0.1	ND
Perfluorooctyl triethoxysilane (POTS)	51851-37-7	mg/kg	0.1	ND
Perfluorododecyl iodide (PFDoDI)	307-60-8	mg/kg	0.1	ND
Perfluorodecyl iodide (PFDI)	423-62-1	mg/kg	0.1	ND
11H-Perfluoroundecanoic acid (11H-PFUnDA) ^{Note (23)}	1765-48-6	mg/kg	0.1	ND

Notes:

- (1) PFOS refer to its salts/derivative including
 - PFOS-K CAS No.: 2795-39-3
 - PFOS-Li CAS No.: 29457-72-5
 - PFOS-Na CAS No.: 4021-47-0
 - PFOS-NH₄ CAS No.: 29081-56-9
 - PFOS-NH₂(C₂H₄OH)₂ CAS No.: 70225-14-8
 - PFOS-N(C₂H₅)₄ CAS No.: 56773-42-3
 - PFOS-N(C₁₀H₂₁)₂(CH₃)₂ CAS No.: 251099-16-8
 - POSF CAS No.: 307-35-7
 - POSF-Mg CAS No.: 91036-71-4
- (2) PFOA refer to its salts/derivative including
 - PFOA-Na CAS No.: 335-95-5
 - PFOA-K CAS No.: 2395-00-8
 - PFOA-Ag CAS No.: 335-93-3
 - PFOA-F CAS No.: 335-66-0
 - APFO CAS No.: 3825-26-1
 - PFOA-Li CAS No.: 17125-58-5
- (3) PFAS classified as both PFOA-related compounds and C9-C14 PFCA-related substances.
 - 8:2 FTS refer to its salts including
 - 8:2 FTS-K CAS No.: 438237-73-1
 - 8:2 FTS-NH₄ CAS No.: 149724-40-3
 - 8:2 FTS-Na CAS No.: 27619-96-1
- (4) PFNA refer to its salts including
 - PFNA-Na CAS No.: 21049-39-8
 - PFNA-NH₄ CAS No.: 4149-60-4
 - PFNA-K CAS No.: 21049-38-7
 - PFNA-Li CAS No.: 60871-92-3



Unless otherwise agreed in writing, this document is issued by the Company subject to its General Conditions of Service printed overleaf, available on request or accessible at <https://www.sgs.com/en/Terms-and-Conditions>. Attention is drawn to the limitation of liability, indemnification and jurisdiction issues defined therein. Any holder of this document is advised that information contained hereon reflects the Company's findings at the time of its intervention only and within the limits of Client's instructions, if any. The Company's sole responsibility is to its Client and this document does not exonerate parties to a transaction from exercising all their rights and obligations under the transaction documents. This document cannot be reproduced except in full, without prior written approval of the Company. Any unauthorized alteration, forgery or falsification of the content or appearance of this document is unlawful and offenders may be prosecuted to the fullest extent of the law. Unless otherwise stated the results shown in this test report refer only to the sample(s) tested.

Attention: To check the authenticity of testing /inspection report & certificate, please contact us at telephone: (86-755) 8307 1443, or email: CN.Doccheck@sgs.com

Test Report

No.: CANEC23007638307

Date: Aug 16, 2023

Page 8 of 36

PFNA-Ag	CAS No.: 7358-16-9
PFDA refer to its salts including	
PFDA-Na	CAS No. 3830-45-3
PFDA-NH ₄	CAS No: 3108-42-7
PFDA-K	CAS No: 51604-85-4
PFDA-Ag	CAS No: 5784-82-7
PFDA-Li	CAS No: 84743-32-8
PFDoDA refer to its salts including	
PFDoDA-NH ₄	CAS No: 3793-74-6
PFDoDA-Na	CAS No: 60872-01-7
(5) PFBS refers to its salts/derivative including	
PFBS-K	CAS No.: 29420-49-3
PFBS-H ₂ O	CAS No.: 59933-66-3
PFBS-Li	CAS No.: 131651-65-5
TPS-PFBS	CAS No.: 144317-44-2
PFBS-S(CH ₃) ₂ C ₆ H ₅	CAS No.: 220133-51-7
PFBS-P(C ₄ H ₉) ₄	CAS No.: 220689-12-3
PFBS-N(C ₂ H ₅) ₄	CAS No.: 25628-08-4
PFBS-F	CAS No.: 375-72-4
PFBS-NC ₄ H ₉ O	CAS No.: 503155-89-3
PFBS-Mg	CAS No.: 507453-86-3
PFBS-NH ₄	CAS No.: 68259-10-9
PFBS-SC ₁₈ H ₂₃ O	CAS No.: 209482-18-8
PFBS-Cl	CAS No.: 2991-84-6
PFBS-Na	CAS No.: 60453-92-1
PFBS-I(C ₆ H ₄) ₂ (C ₄ H ₉) ₂	CAS No.: 194999-85-4
PFBS-NH(C ₂ H ₅ O) ₂	CAS No.: 70225-18-2
(6) PFHxA refers to its salt including	
APFHx	CAS No.: 21615-47-4
PFHxA-Na	CAS No.: 2923-26-4
PFHxA-K	CAS No.: 3109-94-2
PFHxA-F	CAS No.: 355-38-4
PFHxA-Ag	CAS No.: 336-02-7
PFHxA-Li	CAS No.: 90430-61-8
(7) PFHxS refers to its salts including	
PFHxS-Na	CAS No.: 82382-12-5
PFHxS-K	CAS No.: 3871-99-6
PFHxS-Li	CAS No.: 55120-77-9
PFHxS-NH ₄	CAS No.: 68259-08-5
PFHxS-BTPP	CAS No.: 1000597-52-3
PFHxS-N(C ₄ H ₉) ₄	CAS No.: 108427-54-9
PFHxS-N(C ₂ H ₅) ₄	CAS No.: 108427-55-0
PFHxS-NC ₄ H ₉	CAS No.: 1187817-57-7
PFHxS-(NC ₁₀ H ₁₄) ₃ C ₅ H ₄	CAS No.: 1310480-24-0
PFHxS-(NC ₈ H ₁₀) ₂ C ₁₃ H ₁₂	CAS No.: 1310480-27-3
PFHxS-(NC ₈ H ₁₀) ₂ C ₁₇ H ₁₂	CAS No.: 1310480-28-4
PFHxS-C ₄₂ H ₇₀ O ₃₅	CAS No.: 1329995-45-0
PFHxS-C ₄₈ H ₈₀ O ₄₀	CAS No.: 1329995-69-8
TPS-PFHxS	CAS No.: 144116-10-9
PFHxS-C ₄₄ H ₃₇ N ₂ O ₂	CAS No.: 1462414-59-0
PFHxS-I(C ₆ H ₅) ₂	CAS No.: 153443-35-7
PFHxS-TMA	CAS No.: 189274-31-5



Unless otherwise agreed in writing, this document is issued by the Company subject to its General Conditions of Service printed overleaf, available on request or accessible at <https://www.sgs.com/en/Terms-and-Conditions>. Attention is drawn to the limitation of liability, indemnification and jurisdiction issues defined therein. Any holder of this document is advised that information contained hereon reflects the Company's findings at the time of its intervention only and within the limits of Client's instructions, if any. The Company's sole responsibility is to its Client and this document does not exonerate parties to a transaction from exercising all their rights and obligations under the transaction documents. This document cannot be reproduced except in full, without prior written approval of the Company. Any unauthorized alteration, forgery or falsification of the content or appearance of this document is unlawful and offenders may be prosecuted to the fullest extent of the law. Unless otherwise stated the results shown in this test report refer only to the sample(s) tested.

Attention: To check the authenticity of testing inspection report & certificate, please contact us at telephone: (86-755) 8307 1443, or email: CN.Doccheck@sgs.com

Test Report

No.: CANEC23007638307

Date: Aug 16, 2023

Page 9 of 36

PFHxS-NH ₂ (CH ₃) ₃	CAS No.: 202189-84-2
PFHxS-I(C ₆ H ₄) ₂ (C ₄ H ₉) ₂	CAS No.: 213740-81-9
PFHxS-Ga	CAS No.: 341035-71-0
PFHxS-S(C ₇ H ₇) ₂ C ₆ H ₅	CAS No.: 341548-85-4
PFHxS-Sc	CAS No.: 350836-93-0
PFHxS-Nd	CAS No.: 41184-65-0
PFHxS-Y	CAS No.: 41242-12-0
PFHxS-S ₃ (C ₆ H ₅) ₄ (C ₆ H ₄) ₂	CAS No.: 421555-73-9
PFHxS-I(C ₆ H ₄) ₂ (C ₅ H ₁₁) ₂	CAS No.: 421555-74-0
PFHxS-F	CAS No.: 423-50-7
PFHxS-S(C ₆ H ₄) ₃ (C ₄ H ₉) ₃	CAS No.: 425670-70-8
PFHxS-Zn	CAS No.: 70136-72-0
PFHxS-NH(C ₂ H ₅ O) ₂	CAS No.: 70225-16-0
PFHxS-N(C ₂ H ₅) ₃	CAS No.: 72033-41-1
PFHxS-I(C ₆ H ₄) ₂ (C ₄ H ₉) ₂	CAS No.: 866621-50-3
PFHxS-S(C ₆ H ₅) ₂ C ₇ H ₇	CAS No.: 910606-39-2
PFHxS-S(C ₆ H ₅) ₂ C ₁₀ H ₉ O ₂	CAS No.: 911027-68-4
PFHxS-Cs	CAS No.: 92011-17-1
PFHxS-SC ₂₈ H ₃₁ O ₄	CAS No.: 928049-42-7
PFHxS-Cl	CAS No.: 55591-23-6
(8) PFHpS refers to its salts including	
PFHpS-Na	CAS No.: 21934-50-9
PFHpS-K	CAS No.: 60270-55-5
PFHpS-NH ₄	CAS No.: 68259-07-4
PFHpS-Li	CAS No.: 117806-54-9
(9) HFPO-DA refers to its salts including	
HFPO-DA-NH ₄	CAS No.: 62037-80-3
HFPO-DA-K	CAS No.: 67118-55-2
HFPO-DA-F	CAS No.: 2062-98-8
(10) PFDS refer to its salts including	
PFDS-Na	CAS No.: 2806-15-7
PFDS-K	CAS No.: 2806-16-8
PFDS-NH ₄	CAS No.: 67906-42-7
(11) H ₂ PFDA / 8:2 FTCA refer to its salt/derivative including	
8:2 FTCA-P(C ₄ H ₉) ₄	CAS No.: 882489-14-7
(12) H ₄ PFUnDA/ 8:3 FTCA refer to its salts including	
H ₄ PFUnDA-K	CAS No.: 83310-58-1
(13) PFBA refers to its salts including	
PFBA-NH ₄	CAS No.: 10495-86-0
PFBA-Na	CAS No.: 2218-54-4
PFBA-K	CAS No.: 2966-54-3
PFBA-Ag	CAS No.: 3794-64-7
PFBA-Li	CAS No.: 4146-76-3
(14) PFHpA refers to its salts including	
PFHpA-Na	CAS No.: 20109-59-5
PFHpA-K	CAS No.: 21049-36-5
PFHpA-NH ₄	CAS No.: 6130-43-4
PFHpA-Cs	CAS No.: 171198-24-6
PFHpA-Ag	CAS No.: 424-05-5
PFHpA-Li	CAS No.: 60871-90-1
(15) 8:2diPAP refers to its salts including	
8:2diPAP-Na	CAS No.: 114519-85-6



Unless otherwise agreed in writing, this document is issued by the Company subject to its General Conditions of Service printed overleaf, available on request or accessible at <https://www.sgs.com/en/Terms-and-Conditions>. Attention is drawn to the limitation of liability, indemnification and jurisdiction issues defined therein. Any holder of this document is advised that information contained hereon reflects the Company's findings at the time of its intervention only and within the limits of Client's instructions, if any. The Company's sole responsibility is to its Client and this document does not exonerate parties to a transaction from exercising all their rights and obligations under the transaction documents. This document cannot be reproduced except in full, without prior written approval of the Company. Any unauthorized alteration, forgery or falsification of the content or appearance of this document is unlawful and offenders may be prosecuted to the fullest extent of the law. Unless otherwise stated the results shown in this test report refer only to the sample(s) tested.

Attention: To check the authenticity of testing inspection report & certificate, please contact us at telephone: (86-755) 8307 1443, or email: CN.Doccheck@sgs.com

Test Report

No.: CANEC23007638307

Date: Aug 16, 2023

Page 10 of 36

- (16)PFUnDS refers to its salts including
PFUnDS-Na CAS No.: 441296-91-9 (anion)
- (17)PFPeA refers to its salts including
PFPeA-Na CAS No.: 2706-89-0
PFPeA-K CAS No.: 336-23-2
PFPeA-NH₄ CAS No.: 68259-11-0
PFPeA-Li CAS No.: 198482-22-3
PFPeA-Ag CAS No.: 2795-30-4
- (18)PFPeS refers to its salts including
PFPeS-Na CAS No.: 630402-22-1
PFPeS-K CAS No.: 3872-25-1
PFPeS-NH₄ CAS No.: 68259-09-6
- (19)PFNS refers to its salts including
PFNS-Na CAS No.: 98789-57-2
PFNS-NH₄ CAS No.: 17202-41-4
PFNS-K CAS No.: 29359-39-5
- (20)PFDoDS refers to its salts including
PFDoDS-Na CAS No.: 1260224-54-1
- (21)PFTrDS refers to its salts including
PFTrDS-Na CAS No.: 174675-49-1
- (22)PFUnDA refers to its salts including
PFUnDA-Na CAS No.: 60871-96-7
PFUnDA-NH₄ CAS No.: 4234-23-5
PFUnDA-K CAS No.: 30377-53-8
- (23)11H-PFUnDA refers to its salts including
11H-PFUnDA-K CAS No.: 307-71-1
11H-PFUnDA-NH₄ CAS No.: 5081-02-7
- (24)PFTrDA refers to its salts including
PFTrDA-NH₄ CAS No.: 4288-72-6
- (25)PFOSA refers to its salts including
PFOSA-Li CAS No.: 76752-79-9
- (26)6:2 FTS refers to its salts including
6:2 FTS-Na CAS No.: 27619-94-9
6:2 FTS-K CAS No.: 59587-38-1
6:2 FTS-NH₄ CAS No.: 59587-39-2

Tetrabromobisphenol A (TBBP-A)

Test Method: With reference to US EPA 3550C: 2007, analysis was performed by GC-MS or LC-MS or LC-MS/MS.

Test Item(s)	CAS No.	Unit(s)	MDL	A5
Tetrabromobisphenol A(TBBP-A)	79-94-7	mg/kg	5	ND

Alkanes C14-C17, chloro (medium- chain chlorinated paraffins) (MCCPs)

Test Method: With reference to ISO 22818:2021, analysis was performed by GC-NCI-MS.



SGS-CSTC Standards Technical Services Co., Ltd.
Guangzhou Branch Technical Laboratory

Unless otherwise agreed in writing, this document is issued by the Company subject to its General Conditions of Service printed overleaf, available on request or accessible at <https://www.sgs.com/en/Terms-and-Conditions>. Attention is drawn to the limitation of liability, indemnification and jurisdiction issues defined therein. Any holder of this document is advised that information contained hereon reflects the Company's findings at the time of its intervention only and within the limits of Client's instructions, if any. The Company's sole responsibility is to its Client and this document does not exonerate parties to a transaction from exercising all their rights and obligations under the transaction documents. This document cannot be reproduced except in full, without prior written approval of the Company. Any unauthorized alteration, forgery or falsification of the content or appearance of this document is unlawful and offenders may be prosecuted to the fullest extent of the law. Unless otherwise stated the results shown in this test report refer only to the sample(s) tested.
Attention: To check the authenticity of testing / inspection report & certificate, please contact us at telephone: (86-755) 8307 1443, or email: CN.Doccheck@sgs.com

No.198, Kezhu Road, Science City, Economic & Technological Development Area, Guangzhou, Guangdong, China 510663
中国·广东·广州高新技术产业开发区科学城科珠路198号 邮编: 510663

t (86-20) 82155555 www.sgsgroup.com.cn
t (86-20) 82155555 sgs.china@sgs.com

Test Report

No.: CANEC23007638307

Date: Aug 16, 2023

Page 11 of 36

Test Item(s)	CAS No.	Unit(s)	MDL	A5
Alkanes C ₁₄ -C ₁₇ , chloro (medium- chain chlorinated paraffins) (MCCPs)	85535-85-9 and others	mg/kg	50	ND

Polycyclic Aromatic Hydrocarbons (PAHs)

Test Method: With reference to AfPS GS 2019:01 PAK, analysis was performed by GC-MS.

Test Item(s)	CAS No.	Unit(s)	MDL	A5
Benzo(a)pyrene(BaP)	50-32-8	mg/kg	0.1	ND
Benzo(e)pyrene(BeP)	192-97-2	mg/kg	0.1	ND
Benzo(a)anthracene(BaA)	56-55-3	mg/kg	0.1	ND
Benzo(b)Fluoranthene(BbF)	205-99-2	mg/kg	0.1	ND
Benzo(j)fluoranthene(BjF)	205-82-3	mg/kg	0.1	ND
Benzo(k)Fluoranthene(BkF)	207-08-9	mg/kg	0.1	ND
Chrysene(CHR)	218-01-9	mg/kg	0.1	ND
Dibenzo(a,h)Anthracene(DBA)	53-70-3	mg/kg	0.1	ND
Benzo(g,h,i)perylene(BPE)	191-24-2	mg/kg	0.1	ND
Indeno(1,2,3-c,d)pyrene(IPY)	193-39-5	mg/kg	0.1	ND
Phenanthrene(PHE)	85-01-8	mg/kg	0.1	ND
Pyrene(PYR)	129-00-0	mg/kg	0.1	ND
Anthracene(ANT)	120-12-7	mg/kg	0.1	ND
Fluoranthene(FLT)	206-44-0	mg/kg	0.1	ND
Sum of Phenanthrene(PHE), Pyrene(PYR), Anthracene(ANT), Fluoranthene(FLT)	-	mg/kg	-	ND
Naphthalene(NAP)	91-20-3	mg/kg	0.1	ND
Sum of 15 PAHs	-	mg/kg	-	ND
Material Category	-	-	-	-

Notes:

AfPS (German commission for Product Safety) : PAHs requirements

Parameter	Category 1	Category 2	Category 3
	Materials intended to be placed in the mouth, or materials coming into long-term contact with skin	Materials not covered by category 1, coming into long-term contact (more than 30s) or short-term repetitive contact ^c with skin during the intended or foreseeable use ^d .	Materials covered neither by category 1 nor by category 2, coming into short-term contact (up to 30s) with skin during the intended or foreseeable use.



SGS-CSTC Standards Technical Services Co., Ltd.
Guangzhou Branch Technical Laboratory

Unless otherwise agreed in writing, this document is issued by the Company subject to its General Conditions of Service printed overleaf, available on request or accessible at <https://www.sgs.com/en/Terms-and-Conditions>. Attention is drawn to the limitation of liability, indemnification and jurisdiction issues defined therein. Any holder of this document is advised that information contained hereon reflects the Company's findings at the time of its intervention only and within the limits of Client's instructions, if any. The Company's sole responsibility is to its Client and this document does not exonerate parties to a transaction from exercising all their rights and obligations under the transaction documents. This document cannot be reproduced except in full, without prior written approval of the Company. Any unauthorized alteration, forgery or falsification of the content or appearance of this document is unlawful and offenders may be prosecuted to the fullest extent of the law. Unless otherwise stated the results shown in this test report refer only to the sample(s) tested.
Attention: To check the authenticity of testing /inspection report & certificate, please contact us at telephone: (86-755) 8307 1443, or email: CN.Doccheck@sgs.com

No.198, Kezhu Road, Science City, Economic & Technological Development Area, Guangzhou, Guangdong, China 510663
中国·广东·广州高新技术产业开发区科学城科珠路198号 邮编: 510663

t (86-20) 82155555 www.sgs.com.cn
t (86-20) 82155555 sgs.china@sgs.com

	(more than 30s) during the intended use -in toys according to Directive 2009/48/EC or -for the use by children ^{a,b} up to 3 years of age.	a. use by children	b. other consumer products	a. use by children	b. other consumer products
Benzo(a)pyrene (BaP) mg/kg	< 0.2	< 0.2	< 0.5	< 0.5	< 1
Benzo(e)pyrene (BeP) mg/kg	< 0.2	< 0.2	< 0.5	< 0.5	< 1
Benzo(a)anthracene (BaA) mg/kg	< 0.2	< 0.2	< 0.5	< 0.5	< 1
Benzo(b)fluoranthene (BbF) mg/kg	< 0.2	< 0.2	< 0.5	< 0.5	< 1
Benzo(j)fluoranthene (BjF) mg/kg	< 0.2	< 0.2	< 0.5	< 0.5	< 1
Benzo(k)fluoranthene (BkF)mg/kg	< 0.2	< 0.2	< 0.5	< 0.5	< 1
Chrysene (CHR) mg/kg	< 0.2	< 0.2	< 0.5	< 0.5	< 1
Dibenzo(a,h)anthracene (DBA) mg/kg	< 0.2	< 0.2	< 0.5	< 0.5	< 1
Benzo(g,h,i)perylene (BPE) mg/kg	< 0.2	< 0.2	< 0.5	< 0.5	< 1
Indeno(1,2,3-cd)pyrene (IPY) mg/kg	< 0.2	< 0.2	< 0.5	< 0.5	< 1
Phenanthrene (PHE), pyrene (PYR), anthracene (ANT), fluoranthene (FLT), mg/kg	< 1 Sum	< 5 Sum	< 10 Sum	< 20 Sum	< 50 Sum
Naphthalene (NAP) mg/kg	< 1	< 2	< 10	< 10	< 50
Sum of 15 PAHs	<1	< 5	< 10	< 20	< 50

Notes:

- ^a A "Child" is legally defined as a person before reaching the age of 14 years.
- ^b Use by children includes both active and passive contact by children.
- ^c Definition "short-term repetitive contact" taken from REACH Annex XVII entry 50 amendment (Regulation



Unless otherwise agreed in writing, this document is issued by the Company subject to its General Conditions of Service printed overleaf, available on request or accessible at <https://www.sgs.com/en/Terms-and-Conditions>. Attention is drawn to the limitation of liability, indemnification and jurisdiction issues defined therein. Any holder of this document is advised that information contained hereon reflects the Company's findings at the time of its intervention only and within the limits of Client's instructions, if any. The Company's sole responsibility is to its Client and this document does not exonerate parties to a transaction from exercising all their rights and obligations under the transaction documents. This document cannot be reproduced except in full, without prior written approval of the Company. Any unauthorized alteration, forgery or falsification of the content or appearance of this document is unlawful and offenders may be prosecuted to the fullest extent of the law. Unless otherwise stated the results shown in this test report refer only to the sample(s) tested.
Attention: To check the authenticity of testing /inspection report & certificate, please contact us at telephone: (86-755) 8307 1443, or email: CN.Doccheck@sgs.com

Test Report

No.: CANEC23007638307

Date: Aug 16, 2023

Page 13 of 36

(EC) No.1272/2013)

^d According to the definition of the German Product Safety Act (ProdSG) (chapter 1 Article 2 No. 28) "foreseeable use" shall mean the use of a product in a manner that the person placing it on the market, has not intended, but which could be reasonably foreseeable.

Remark:

The German committee on Product Safety (AfPS) published a new PAHs document (AfPS GS 2019:01 PAK) on April 10, 2020, which will be binding for the issue of GS mark certificate from July 1, 2020.

Persistent, Bioaccumulative, and Toxic (PBT) Chemicals under US EPA Toxic Substances Control Act (TSCA) Section 6(h)

Test Method: SGS In-house method (SGS-CCL-TOP-149-07, With reference to US EPA Method 3550C:2007), analysis was performed by GC-MS.

Test Item(s)	CAS No.	Limit	Unit(s)	MDL	A5
Decabromodiphenyl ether (DecaBDE) ^{Δ1}	1163-19-5	Prohibited	mg/kg	5	ND
Phenol, isopropylated phosphate (3:1) (PIP 3:1) ^{Δ2}	68937-41-7	Prohibited	mg/kg	5	ND
2,4,6-Tris(tert-butyl)phenol (2,4,6-TTBP) ^{Δ3}	732-26-3	3000	mg/kg	5	ND
Hexachlorobutadiene (HCBD)	87-68-3	Prohibited	mg/kg	5	ND
Pentachlorothiophenol (PCTP)	133-49-3	10000	mg/kg	5	ND
Conclusion					Pass

Notes:

(1) The regulation is available at the following link.
<https://www.epa.gov/assessing-and-managing-chemicals-under-tsca/persistent-bioaccumulative-and-toxic-pbt-chemicals-under>

(2) ^{Δ1}: The submitted sample is exempted if it is plastic for recycling from products or articles containing Deca-BDE.

(3) ^{Δ2}: The submitted sample is exempted from the regulated scope if it is anyone of the following:
 - Hydraulic fluids for aviation or military industry;
 - Lubricants and grease;
 - New and replacement parts for motor and aerospace vehicles;
 - Intermediate in a closed system to produce cyanoacrylate adhesive;
 - Specialized engine air filters for locomotive and marine applications;
 - Plastic for recycling from products or articles containing PIP (3:1);
 - Finished products or articles made of plastic recycled from products or articles containing PIP (3:1).

(4) ^{Δ3}: The submitted sample is out of the regulated scope if it is not oil or lubricant.

Halogen

Test Method: With reference to EN 14582:2016, analysis was performed by IC.

Test Item(s)	Unit(s)	MDL	A5
Fluorine(F)	mg/kg	20	608



Unless otherwise agreed in writing, this document is issued by the Company subject to its General Conditions of Service printed overleaf, available on request or accessible at <https://www.sgs.com/en/Terms-and-Conditions>. Attention is drawn to the limitation of liability, indemnification and jurisdiction issues defined therein. Any holder of this document is advised that information contained hereon reflects the Company's findings at the time of its intervention only and within the limits of Client's instructions, if any. The Company's sole responsibility is to its Client and this document does not exonerate parties to a transaction from exercising all their rights and obligations under the transaction documents. This document cannot be reproduced except in full, without prior written approval of the Company. Any unauthorized alteration, forgery or falsification of the content or appearance of this document is unlawful and offenders may be prosecuted to the fullest extent of the law. Unless otherwise stated the results shown in this test report refer only to the sample(s) tested.
Attention: To check the authenticity of testing / inspection report & certificate, please contact us at telephone: (86-755) 8307 1443, or email: CN.Doccheck@sgs.com

Test Report

No.: CANEC23007638307

Date: Aug 16, 2023

Page 14 of 36

Test Item(s)	Unit(s)	MDL	A5
Chlorine(Cl)	mg/kg	50	134
Bromine(Br)	mg/kg	50	17427
Iodine(I)	mg/kg	50	ND

Element(s)

Test Method: With reference to US EPA 3052:1996, analysis was performed by ICP-OES/AAS.

Test Item(s)	Unit(s)	MDL	A5
Arsenic(As)	mg/kg	10	ND
Beryllium(Be)	mg/kg	5	ND
Nickel (Ni)	mg/kg	5	ND
Antimony(Sb)	mg/kg	10	ND

Red Phosphorus

Test Method: SGS In-house method (SGS-CCL-TOP-215-01), analysis was performed by PY-GC/MS/ICP-OES / GC-MS.

Test Item(s)	CAS No.	Unit(s)	MDL	A5
Red Phosphorus	7723-14-0	mg/kg	500	ND

Polychlorinated Biphenyls (PCBs)

Test Method: SGS In-house method (GZTC CHEM-TOP-032-01, with reference to EPA 8082A:2007), analysis was performed by GC-ECD/GC-MS.

Test Item(s)	CAS No.	Unit(s)	MDL	A5
2,4,4'-Trichlorobiphenyl(PCB28)	7012-37-5	mg/kg	0.5	ND
2,2',5,5'-Tetrachlorobiphenyl(PCB52)	35693-99-3	mg/kg	0.5	ND
2,2',4,5,5'-Pentachlorobiphenyl(PCB101)	37680-73-2	mg/kg	0.5	ND
2,3',4,4',5-Pentachlorobiphenyl(PCB118)	31508-00-6	mg/kg	0.5	ND
2,2',3,4,4',5'-Hexachlorobiphenyl(PCB138)	35065-28-2	mg/kg	0.5	ND
2,2',4,4',5,5'-Hexachlorobiphenyl(PCB153)	35065-27-1	mg/kg	0.5	ND
2,2',3,4,4',5,5'-Heptachlorobiphenyl(PCB180)	35065-29-3	mg/kg	0.5	ND

Asbestos

Test Method: With reference to NIOSH 9000:2015 / NIOSH 9002:1994, analysis was performed by XRD / PLM.



Unless otherwise agreed in writing, this document is issued by the Company subject to its General Conditions of Service printed overleaf, available on request or accessible at <https://www.sgs.com/en/Terms-and-Conditions>. Attention is drawn to the limitation of liability, indemnification and jurisdiction issues defined therein. Any holder of this document is advised that information contained herein reflects the Company's findings at the time of its intervention only and within the limits of Client's instructions, if any. The Company's sole responsibility is to its Client and this document does not exonerate parties to a transaction from exercising all their rights and obligations under the transaction documents. This document cannot be reproduced except in full, without prior written approval of the Company. Any unauthorized alteration, forgery or falsification of the content or appearance of this document is unlawful and offenders may be prosecuted to the fullest extent of the law. Unless otherwise stated the results shown in this test report refer only to the sample(s) tested.
Attention: To check the authenticity of testing / inspection report & certificate, please contact us at telephone: (86-755) 8307 1443, or email: CN.Doccheck@sgs.com

Test Report

No.: CANEC23007638307

Date: Aug 16, 2023

Page 15 of 36

Test Item(s)	CAS No.	Unit(s)	MDL	A5
Chrysotile	12001-29-5 /132207-32-0	%(m/m)	0.1	Negative
Amosite	12172-73-5	%(m/m)	0.1	Negative
Crocidolite	12001-28-4	%(m/m)	0.1	Negative
Anthophyllite	77536-67-5	%(m/m)	0.1	Negative
Tremolite	77536-68-6	%(m/m)	0.1	Negative
Actinolite	77536-66-4	%(m/m)	0.1	Negative

Notes:

(1) Negative = the absence of asbestos, Positive = the presence of asbestos.

Benzotriazole UV Absorbent

Test Method: SGS In-house method(GZTC CHEM-TOP-102, with reference to EPA 3550C:2007), analysis was performed by GC-MS.

Test Item(s)	CAS No.	Unit(s)	MDL	A5
2-Benzotriazol-2-yl-4,6-di-tert-butylphenol(UV 320)	3846-71-7	mg/kg	5	ND
2-(2H-Benzotriazol-2-yl)-4(tert-butyl)-6-(sec-butyl)phenol (UV 350)	36437-37-3	mg/kg	5	ND
2-(2H-Benzotriazol-2-yl)-4,6-di-tert-pentylphenol(UV 328)	25973-55-1	mg/kg	5	ND
2,4-Di-tert-butyl-6-(5-chlorobenzotriazol-2-yl)phenol (UV 327)	3864-99-1	mg/kg	5	ND

Bisphenol-A

Test Method: SGS In-house method (GZTC CHEM-TOP-075-02, With reference to EPA 3550C:2007 & EPA 8321B:2007), analysis was performed by LC-MS.

Test Item(s)	CAS No.	Unit(s)	MDL	A5
Bisphenol-A	80-05-7	mg/kg	1.0	ND

Chlorinated Paraffins

Test Method: With reference to ISO 22818:2021,analysis was performed by GC-NCI-MS.

Test Item(s)	CAS No.	Unit(s)	MDL	A5
Short Chain Chlorinate Paraffins(SCCP)(C ₁₀ -C ₁₃)	85535-84-8	mg/kg	50	ND

Dimethyl fumarate (DMFu)

Test Method: Solvent extraction, analysis was performed by GC-MS.



Unless otherwise agreed in writing, this document is issued by the Company subject to its General Conditions of Service printed overleaf, available on request or accessible at <https://www.sgs.com/en/Terms-and-Conditions>. Attention is drawn to the limitation of liability, indemnification and jurisdiction issues defined therein. Any holder of this document is advised that information contained hereon reflects the Company's findings at the time of its intervention only and within the limits of Client's instructions, if any. The Company's sole responsibility is to its Client and this document does not exonerate parties to a transaction from exercising all their rights and obligations under the transaction documents. This document cannot be reproduced except in full, without prior written approval of the Company. Any unauthorized alteration, forgery or falsification of the content or appearance of this document is unlawful and offenders may be prosecuted to the fullest extent of the law. Unless otherwise stated the results shown in this test report refer only to the sample(s) tested.
Attention: To check the authenticity of testing /inspection report & certificate, please contact us at telephone: (86-755) 8307 1443, or email: CN.Doccheck@sgs.com

Test Item(s)	CAS No.	Unit(s)	MDL	A5
Dimethyl Fumarate (DMFu)	624-49-7	mg/kg	0.1	ND

Formaldehyde

Test Method: With reference to ISO 14184-1:2011, analysis was performed by UV-Vis.

Test Item(s)	Unit(s)	MDL	A5
Formaldehyde	mg/kg	16	ND

Hexabromocyclododecane (HBCDD)

Test Method: With reference to IEC 62321-9:2021, analysis was performed by GC-MS.

Test Item(s)	CAS No.	Unit(s)	MDL	A5
Hexabromocyclododecane (HBCDD) and all major diastereoisomers identified (α -HBCDD, β -HBCDD, γ -HBCDD)	134237-50-6 /134237-51-7 /134237-52-8 /25637-99-4 /3194-55-6	mg/kg	20	ND

Organic-Tin compounds

Test Method: With reference to ISO 17353:2004, analysis was performed by GC-MS.

Test Item(s)	Unit(s)	MDL	A5
Dibutyl tin(DBT)	mg/kg	0.02	ND
Tributyl tin(TBT)	mg/kg	0.02	ND
Diocetyl tin(DOT)	mg/kg	0.02	ND
Triphenyl tin(TPhT)	mg/kg	0.02	ND
Tricyclohexyltin(TCyHT)	mg/kg	0.02	ND
Trimethyltin(TMT)	mg/kg	0.02	ND
Triocetyl tin(TOT)	mg/kg	0.02	ND
Tri-n-propyltin(TPT)	mg/kg	0.02	ND

Phthalates

Test Method: With reference to IEC 62321-8:2017, analysis was performed by GC-MS.

Test Item(s)	CAS No.	Unit(s)	MDL	A5
Dibutyl Phthalate(DBP)	84-74-2	mg/kg	50	ND
Bis-(2-ethylhexyl) Phthalate(DEHP)	117-81-7	mg/kg	50	ND
Benzyl Butyl Phthalate(BBP)	85-68-7	mg/kg	50	ND
Diisononyl Phthalate (DINP)	28553-12-0 /68515-48-0	mg/kg	50	ND



Test Report

No.: CANEC23007638307

Date: Aug 16, 2023

Page 17 of 36

Test Item(s)	CAS No.	Unit(s)	MDL	A5
Di-n-Octyl Phthalate(DNOP)	117-84-0	mg/kg	50	ND
Diisodecyl Phthalate (DIDP)	26761-40-0 /68515-49-1	mg/kg	50	ND
Diisobutyl Phthalate(DIBP)	84-69-5	mg/kg	50	ND
Bis(2-methoxyethyl)phthalate(DMEP)	117-82-8	mg/kg	50	ND
Di-n-Hexyl Phthalate(DnHP)	84-75-3	mg/kg	50	ND
Dipentyl Phthalate (DPENP/DnPP)	131-18-0	mg/kg	50	ND
Diphenyl Phthalate(DPhP)	84-62-8	mg/kg	50	ND
Diundecyl Phthalate(DUDP)	3648-20-2	mg/kg	50	ND
Dimethyl Phthalate(DMP)	131-11-3	mg/kg	50	ND
Diethyl Phthalate(DEP)	84-66-2	mg/kg	50	ND
Dipropyl Phthalate(DPrP)	131-16-8	mg/kg	50	ND
Dicyclohexyl Phthalate(DCHP)	84-61-7	mg/kg	50	ND
Dibenzyl Phthalate(DBzP)	523-31-9	mg/kg	50	ND
Dinonyl Phthalate(DNP)	84-76-4	mg/kg	50	ND
Diisooctyl Phthalate(DIOP)	27554-26-3	mg/kg	50	ND
Diallyl Phthalate(DAP)	131-17-9	mg/kg	50	ND
n-Decyl-n-Octyl Phthalate(nDnOP)	119-07-3	mg/kg	50	ND
Di-n-Decyl Phthalate(DnDP)	84-77-5	mg/kg	50	ND
Diisopentyl Phthalate(DIPP)	605-50-5	mg/kg	50	ND
n-pentyl Isopentyl Phthalate(nPIPP)	776297-69-9	mg/kg	50	ND
Bis(2-n-butoxyethyl)Phthalate(DBEP)	117-83-9	mg/kg	50	ND
Bis(4-methyl-2-pentyl)Phthalate(BMPP)	146-50-9	mg/kg	50	ND
Bis(2-ethoxyethyl)Phthalate(DEEP)	605-54-9	mg/kg	50	ND
1,2-Benzenedicarboxylic Acid,di-C6-8-branched alkyl esters,C7-rich(DIHP)	71888-89-6	mg/kg	50	ND
Di-n-Heptyl Phthalate(DnHpP)	3648-21-3	mg/kg	50	ND
1,2-Benzenedicarboxylic Acid,Di-C7-11-Branched and Linear Alkyl Esters(DHNUP)	68515-42-4	mg/kg	50	ND
1,2-Benzenedicarboxylic Acid,Dipentyl Ester,Branched and Linear (DPP)	84777-06-0	mg/kg	50	ND
Ditridecyl Phthalate(DTDP)	119-06-2	mg/kg	50	ND
1,2-benzenedicarboxylic Acid,dihexyl ester branched and linear(DHxP)	68515-50-4	mg/kg	50	ND
Di-(2-Ethylhexyl)Adipate(DEHA)	103-23-1	mg/kg	50	ND
Dioctyl Terephthalate(DOTP)	6422-86-2	mg/kg	50	ND
Diisononyl Adipate(DINA)	33703-08-1	mg/kg	50	ND
Di(2-propylheptyl)Phthalate(DPHpP)	53306-54-0	mg/kg	50	ND
Acetyl Tributyl Citrate(ATBC)	77-90-7	mg/kg	50	ND
Trioctyl trimellitate(TOTM)	3319-31-1	mg/kg	50	ND

Polyvinyl chloride (PVC)

Test Method: SGS In-house method (SGS-CCL-TOP-066-01), analysis was performed by FTIR/HATR.

Test Item(s)	A5
Polyvinyl chloride (PVC)	Negative



SGS-CST Standards Technical Services Co., Ltd.
Guangzhou Branch Technical Laboratory

Unless otherwise agreed in writing, this document is issued by the Company subject to its General Conditions of Service printed overleaf, available on request or accessible at <https://www.sgs.com/en/Terms-and-Conditions>. Attention is drawn to the limitation of liability, indemnification and jurisdiction issues defined therein. Any holder of this document is advised that information contained hereon reflects the Company's findings at the time of its intervention only and within the limits of Client's instructions, if any. The Company's sole responsibility is to its Client and this document does not exonerate parties to a transaction from exercising all their rights and obligations under the transaction documents. This document cannot be reproduced except in full, without prior written approval of the Company. Any unauthorized alteration, forgery or falsification of the content or appearance of this document is unlawful and offenders may be prosecuted to the fullest extent of the law. Unless otherwise stated the results shown in this test report refer only to the sample(s) tested.
Attention: To check the authenticity of testing / inspection report & certificate, please contact us at telephone: (86-755) 8307 1443, or email: CN.Doccheck@sgs.com

No.198, Kezhu Road, Science City, Economic & Technological Development Area, Guangzhou, Guangdong, China 510663
中国·广东·广州高新技术产业开发区科学城科珠路198号 邮编: 510663

t (86-20) 82155555 www.sgsgroup.com.cn
t (86-20) 82155555 sgs.china@sgs.com

Notes:

(1) Negative=Undetectable, Positive=Detectable

Unless otherwise stated, the decision rule for conformity reporting is based on Binary Statement for Simple Acceptance Rule ($w=0$) stated in ILAC-G8:09/2019.



Unless otherwise agreed in writing, this document is issued by the Company subject to its General Conditions of Service printed overleaf, available on request or accessible at <https://www.sgs.com/en/Terms-and-Conditions>. Attention is drawn to the limitation of liability, indemnification and jurisdiction issues defined therein. Any holder of this document is advised that information contained hereon reflects the Company's findings at the time of its intervention only and within the limits of Client's instructions, if any. The Company's sole responsibility is to its Client and this document does not exonerate parties to a transaction from exercising all their rights and obligations under the transaction documents. This document cannot be reproduced except in full, without prior written approval of the Company. Any unauthorized alteration, forgery or falsification of the content or appearance of this document is unlawful and offenders may be prosecuted to the fullest extent of the law. Unless otherwise stated the results shown in this test report refer only to the sample(s) tested.
Attention: To check the authenticity of testing /inspection report & certificate, please contact us at telephone: (86-755) 8307 1443, or email: CN.Doccheck@sgs.com

SGS-CST Standards Technical Services Co., Ltd.
Guangzhou Branch Technical Laboratory

No.198, Kezhu Road, Science City, Economic & Technological Development Area, Guangzhou, Guangdong, China 510663
中国·广东·广州高新技术产业开发区科学城科珠路198号 邮编: 510663

t (86-20) 82155555 www.sgsgroup.com.cn
t (86-20) 82155555 sgs.china@sgs.com

Elements Testing Flow Chart

These samples were dissolved totally by pre-conditioning method according to below flow chart.

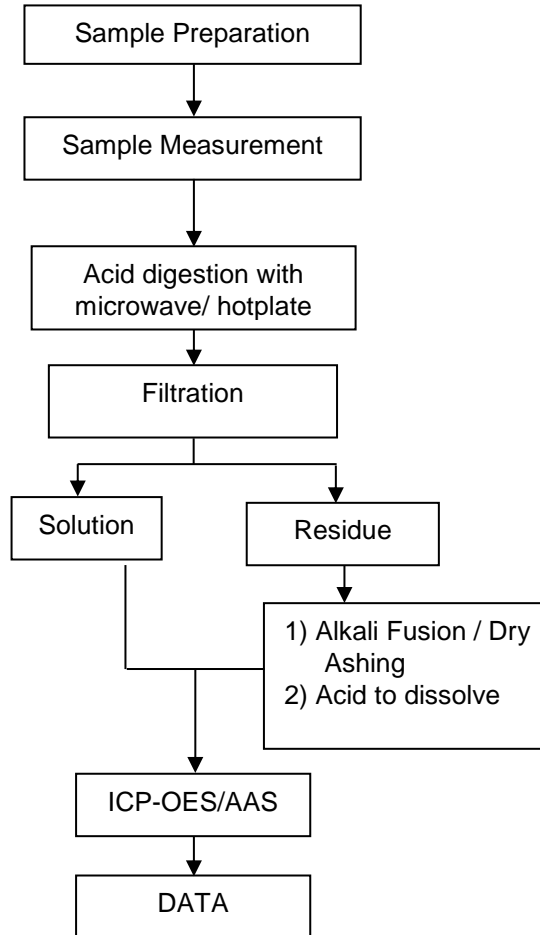

ATTACHMENTS

Hexavalent Chromium (Cr(VI)) Testing Flow Chart

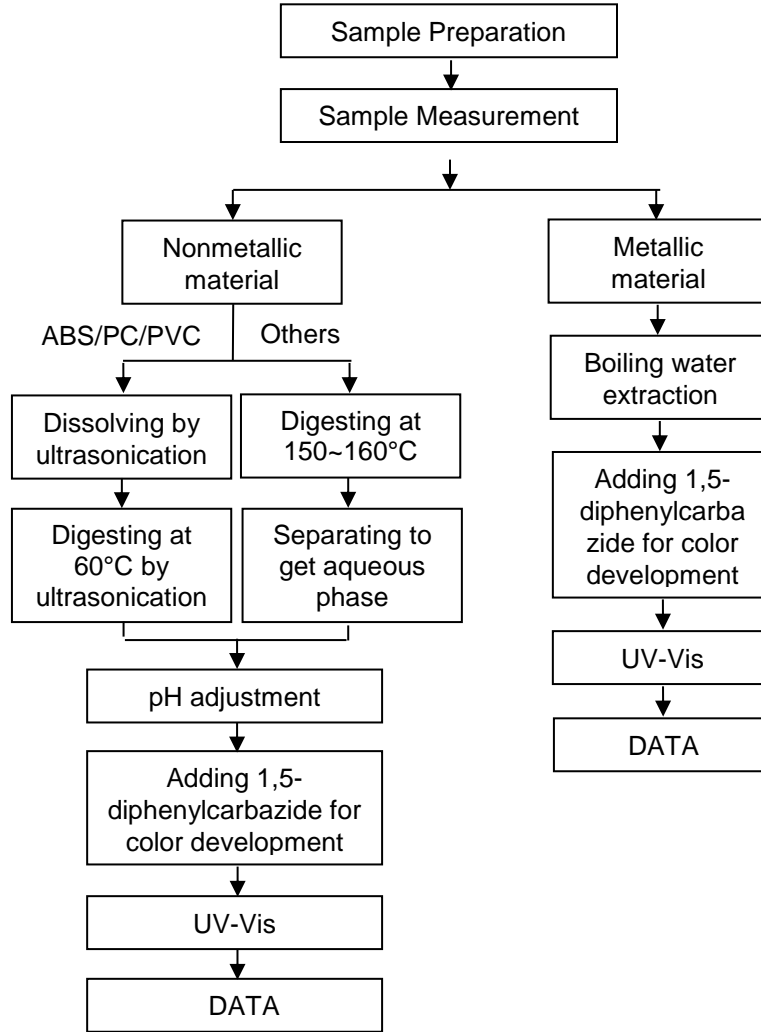

Unless otherwise agreed in writing, this document is issued by the Company subject to its General Conditions of Service printed overleaf, available on request or accessible at <https://www.sgs.com/en/Terms-and-Conditions>. Attention is drawn to the limitation of liability, indemnification and jurisdiction issues defined therein. Any holder of this document is advised that information contained hereon reflects the Company's findings at the time of its intervention only and within the limits of Client's instructions, if any. The Company's sole responsibility is to its Client and this document does not exonerate parties to a transaction from exercising all their rights and obligations under the transaction documents. This document cannot be reproduced except in full, without prior written approval of the Company. Any unauthorized alteration, forgery or falsification of the content or appearance of this document is unlawful and offenders may be prosecuted to the fullest extent of the law. Unless otherwise stated the results shown in this test report refer only to the sample(s) tested.

Attention: To check the authenticity of testing /inspection report & certificate, please contact us at telephone: (86-755) 8307 1443, or email: CN.Doccheck@sgs.com

PBBs/PBDEs Testing Flow Chart

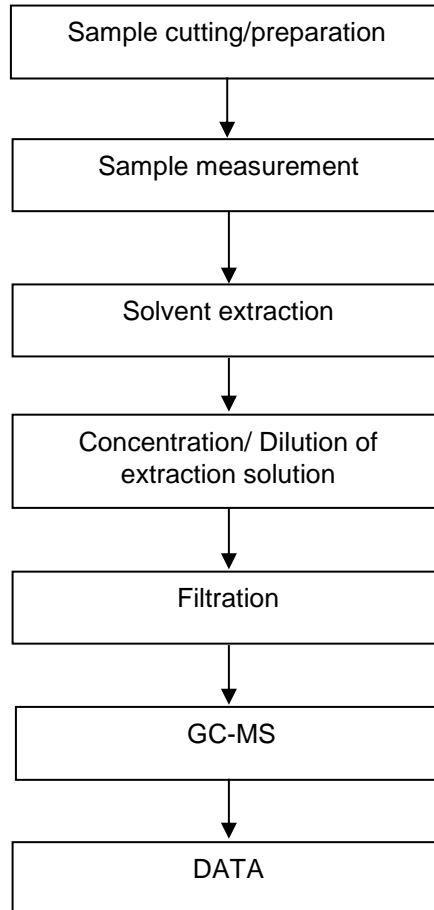

Phthalates Testing Flow Chart

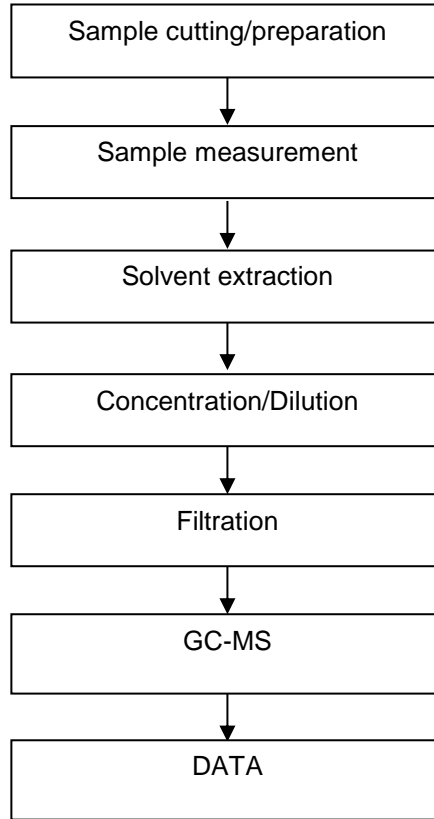

Unless otherwise agreed in writing, this document is issued by the Company subject to its General Conditions of Service printed overleaf, available on request or accessible at <https://www.sgs.com/en/Terms-and-Conditions>. Attention is drawn to the limitation of liability, indemnification and jurisdiction issues defined therein. Any holder of this document is advised that information contained hereon reflects the Company's findings at the time of its intervention only and within the limits of Client's instructions, if any. The Company's sole responsibility is to its Client and this document does not exonerate parties to a transaction from exercising all their rights and obligations under the transaction documents. This document cannot be reproduced except in full, without prior written approval of the Company. Any unauthorized alteration, forgery or falsification of the content or appearance of this document is unlawful and offenders may be prosecuted to the fullest extent of the law. Unless otherwise stated the results shown in this test report refer only to the sample(s) tested.
Attention: To check the authenticity of testing /inspection report & certificate, please contact us at telephone: (86-755) 8307 1443, or email: CN.Doccheck@sgs.com

PFASs/ PFOS/PFOA Testing Flow Chart

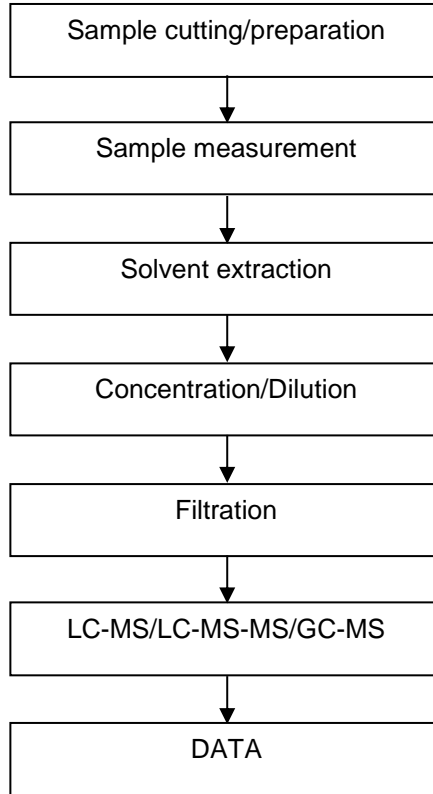

ATTACHMENTS

TBBP-A Testing Flow Chart

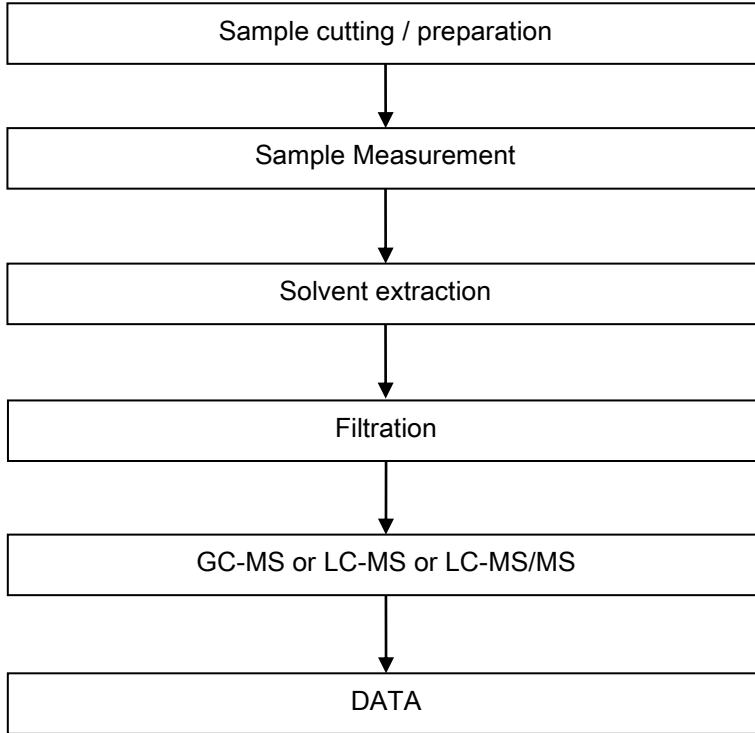

Chlorinated Paraffin Testing Flow Chart

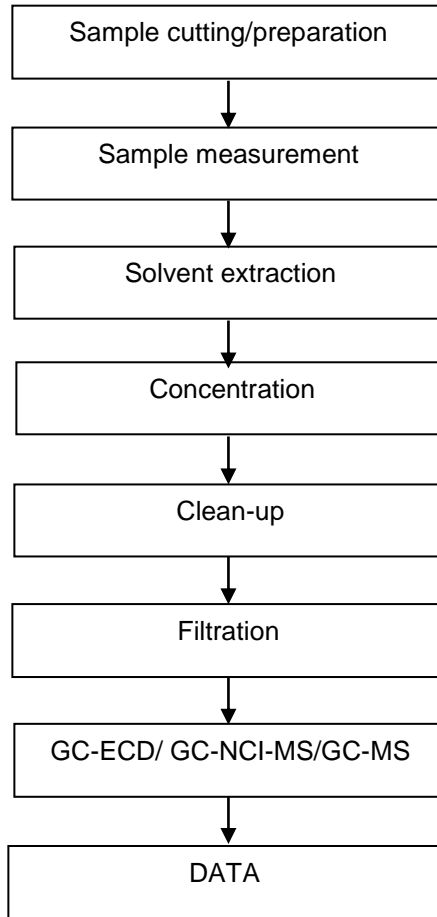

PAHs Testing Flow Chart

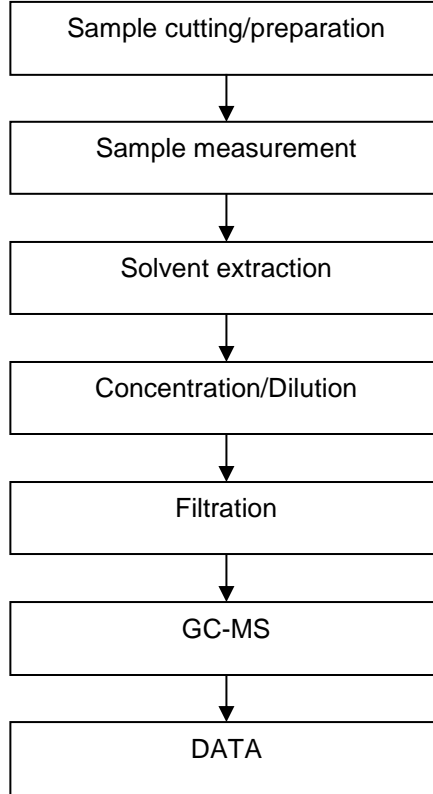

Unless otherwise agreed in writing, this document is issued by the Company subject to its General Conditions of Service printed overleaf, available on request or accessible at <https://www.sgs.com/en/Terms-and-Conditions>. Attention is drawn to the limitation of liability, indemnification and jurisdiction issues defined therein. Any holder of this document is advised that information contained hereon reflects the Company's findings at the time of its intervention only and within the limits of Client's instructions, if any. The Company's sole responsibility is to its Client and this document does not exonerate parties to a transaction from exercising all their rights and obligations under the transaction documents. This document cannot be reproduced except in full, without prior written approval of the Company. Any unauthorized alteration, forgery or falsification of the content or appearance of this document is unlawful and offenders may be prosecuted to the fullest extent of the law. Unless otherwise stated the results shown in this test report refer only to the sample(s) tested.
Attention: To check the authenticity of testing /inspection report & certificate, please contact us at telephone: (86-755) 8307 1443, or email: CN.Doccheck@sgs.com

ATTACHMENTS

Persistent, Bioaccumulative, and Toxic (PBT) Chemicals Testing Flow Chart

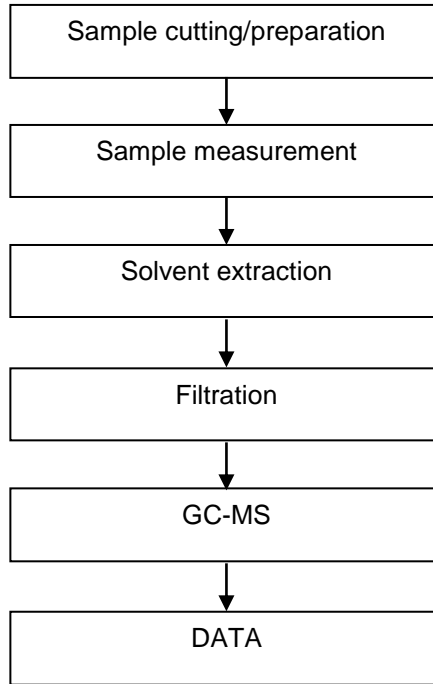

Unless otherwise agreed in writing, this document is issued by the Company subject to its General Conditions of Service printed overleaf, available on request or accessible at <https://www.sgs.com/en/Terms-and-Conditions>. Attention is drawn to the limitation of liability, indemnification and jurisdiction issues defined therein. Any holder of this document is advised that information contained hereon reflects the Company's findings at the time of its intervention only and within the limits of Client's instructions, if any. The Company's sole responsibility is to its Client and this document does not exonerate parties to a transaction from exercising all their rights and obligations under the transaction documents. This document cannot be reproduced except in full, without prior written approval of the Company. Any unauthorized alteration, forgery or falsification of the content or appearance of this document is unlawful and offenders may be prosecuted to the fullest extent of the law. Unless otherwise stated the results shown in this test report refer only to the sample(s) tested.
Attention: To check the authenticity of testing /inspection report & certificate, please contact us at telephone: (86-755) 8307 1443, or email: CN.Doccheck@sgs.com

Halogen Testing Flow Chart

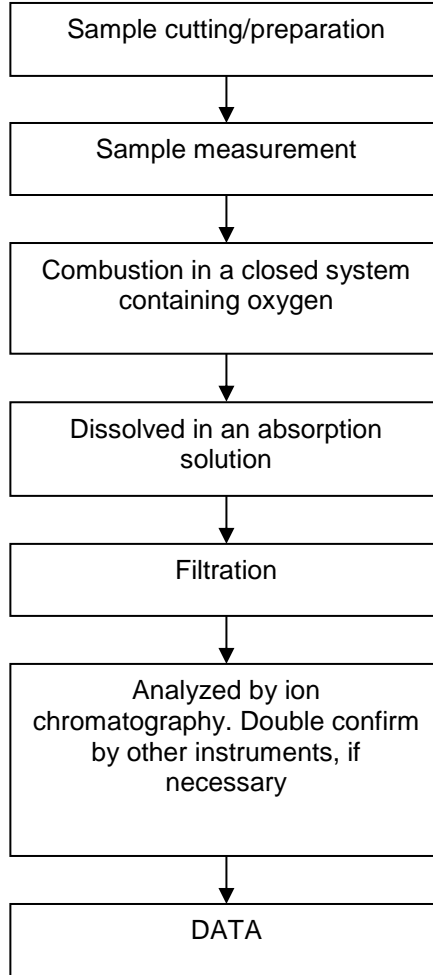

Elements Testing Flow Chart

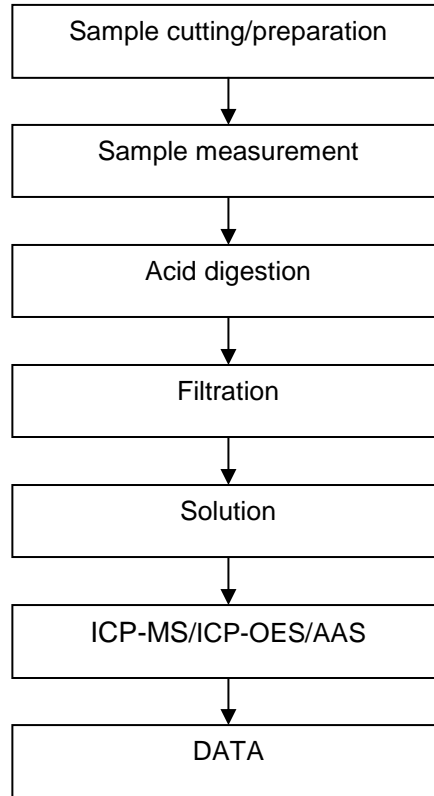

Unless otherwise agreed in writing, this document is issued by the Company subject to its General Conditions of Service printed overleaf, available on request or accessible at <https://www.sgs.com/en/Terms-and-Conditions>. Attention is drawn to the limitation of liability, indemnification and jurisdiction issues defined therein. Any holder of this document is advised that information contained hereon reflects the Company's findings at the time of its intervention only and within the limits of Client's instructions, if any. The Company's sole responsibility is to its Client and this document does not exonerate parties to a transaction from exercising all their rights and obligations under the transaction documents. This document cannot be reproduced except in full, without prior written approval of the Company. Any unauthorized alteration, forgery or falsification of the content or appearance of this document is unlawful and offenders may be prosecuted to the fullest extent of the law. Unless otherwise stated the results shown in this test report refer only to the sample(s) tested.
Attention: To check the authenticity of testing /inspection report & certificate, please contact us at telephone: (86-755) 8307 1443, or email: CN.Doccheck@sgs.com

ATTACHMENTS

Red phosphorus Testing Flow Chart

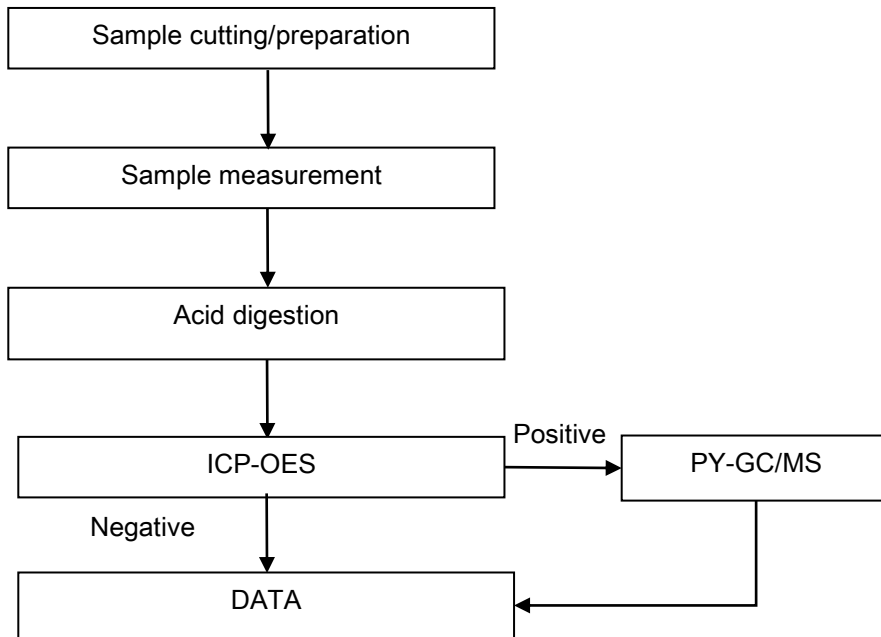

Unless otherwise agreed in writing, this document is issued by the Company subject to its General Conditions of Service printed overleaf, available on request or accessible at <https://www.sgs.com/en/Terms-and-Conditions>. Attention is drawn to the limitation of liability, indemnification and jurisdiction issues defined therein. Any holder of this document is advised that information contained hereon reflects the Company's findings at the time of its intervention only and within the limits of Client's instructions, if any. The Company's sole responsibility is to its Client and this document does not exonerate parties to a transaction from exercising all their rights and obligations under the transaction documents. This document cannot be reproduced except in full, without prior written approval of the Company. Any unauthorized alteration, forgery or falsification of the content or appearance of this document is unlawful and offenders may be prosecuted to the fullest extent of the law. Unless otherwise stated the results shown in this test report refer only to the sample(s) tested.

Attention: To check the authenticity of testing /inspection report & certificate, please contact us at telephone: (86-755) 8307 1443, or email: CN.Doccheck@sgs.com

BPA Testing Flow Chart

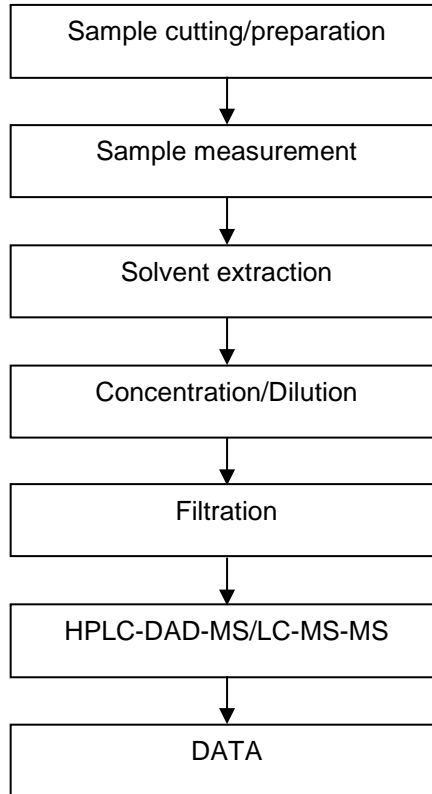

Unless otherwise agreed in writing, this document is issued by the Company subject to its General Conditions of Service printed overleaf, available on request or accessible at <https://www.sgs.com/en/Terms-and-Conditions>. Attention is drawn to the limitation of liability, indemnification and jurisdiction issues defined therein. Any holder of this document is advised that information contained hereon reflects the Company's findings at the time of its intervention only and within the limits of Client's instructions, if any. The Company's sole responsibility is to its Client and this document does not exonerate parties to a transaction from exercising all their rights and obligations under the transaction documents. This document cannot be reproduced except in full, without prior written approval of the Company. Any unauthorized alteration, forgery or falsification of the content or appearance of this document is unlawful and offenders may be prosecuted to the fullest extent of the law. Unless otherwise stated the results shown in this test report refer only to the sample(s) tested.
Attention: To check the authenticity of testing /inspection report & certificate, please contact us at telephone: (86-755) 8307 1443, or email: CN.Doccheck@sgs.com

DMF (Dimethyl fumarate) Testing Flow Chart

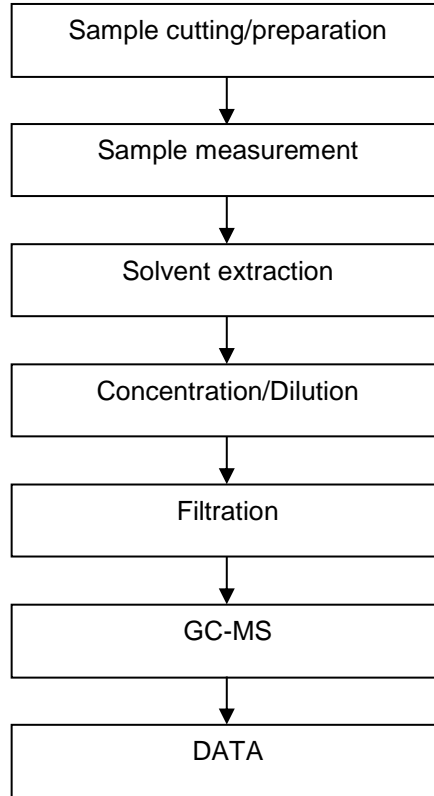

HBCDD Testing Flow Chart

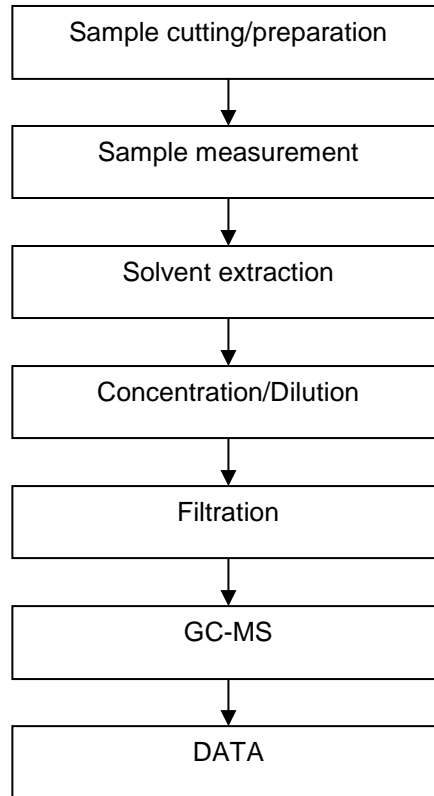

Unless otherwise agreed in writing, this document is issued by the Company subject to its General Conditions of Service printed overleaf, available on request or accessible at <https://www.sgs.com/en/Terms-and-Conditions>. Attention is drawn to the limitation of liability, indemnification and jurisdiction issues defined therein. Any holder of this document is advised that information contained hereon reflects the Company's findings at the time of its intervention only and within the limits of Client's instructions, if any. The Company's sole responsibility is to its Client and this document does not exonerate parties to a transaction from exercising all their rights and obligations under the transaction documents. This document cannot be reproduced except in full, without prior written approval of the Company. Any unauthorized alteration, forgery or falsification of the content or appearance of this document is unlawful and offenders may be prosecuted to the fullest extent of the law. Unless otherwise stated the results shown in this test report refer only to the sample(s) tested.
Attention: To check the authenticity of testing /inspection report & certificate, please contact us at telephone: (86-755) 8307 1443, or email: CN.Doccheck@sgs.com

Organotin Testing Flow Chart

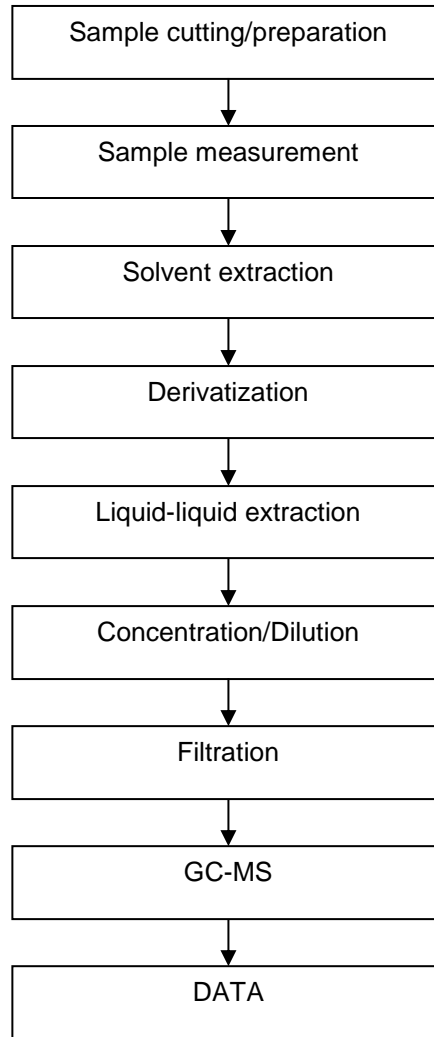

PVC Testing Flow Chart

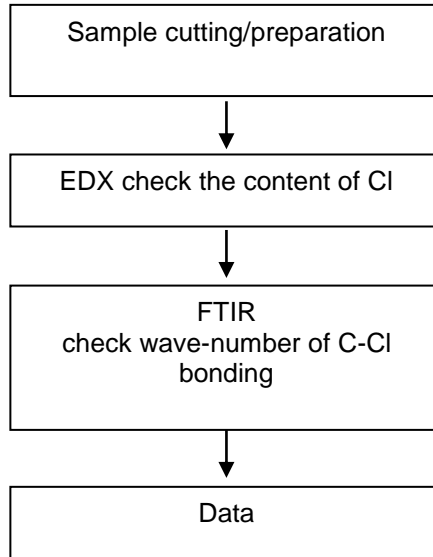

Test Report

No.: CANEC23007638307

Date: Aug 16, 2023

Page 36 of 36

Sample Photo:



SGS authenticate the photo on original report only
*** End of Report ***



SGS-CSTC Standards Technical Services Co., Ltd.
Guangzhou Branch, Technical Services CA, Guangzhou, China

Unless otherwise agreed in writing, this document is issued by the Company subject to its General Conditions of Service printed overleaf, available on request or accessible at <https://www.sgs.com/en/Terms-and-Conditions>. Attention is drawn to the limitation of liability, indemnification and jurisdiction issues defined therein. Any holder of this document is advised that information contained hereon reflects the Company's findings at the time of its intervention only and within the limits of Client's instructions, if any. The Company's sole responsibility is to its Client and this document does not exonerate parties to a transaction from exercising all their rights and obligations under the transaction documents. This document cannot be reproduced except in full, without prior written approval of the Company. Any unauthorized alteration, forgery or falsification of the content or appearance of this document is unlawful and offenders may be prosecuted to the fullest extent of the law. Unless otherwise stated the results shown in this test report refer only to the sample(s) tested.

Attention: To check the authenticity of testing /inspection report & certificate, please contact us at telephone: (86-755) 8307 1443, or email: CN.Doccheck@sgs.com

No.198, Kezhu Road, Science City, Economic & Technological Development Area, Guangzhou, Guangdong, China 510663
中国·广东·广州高新技术产业开发区科学城科珠路198号 邮编: 510663

t (86-20) 82155555 www.sgsgroup.com.cn
t (86-20) 82155555 sgs.china@sgs.com